



Smart Current Transformer

Featuring LoRaWAN®

CT10x

User Guide



Safety Precautions

Milesight will not shoulder responsibility for any losses or damages resulting from not following the instructions of this operating guide.

- ❖ The device must not be modified in any way.
- ❖ The installation and maintenance must be conducted by a qualified service person and should strictly comply with the electrical safety regulations of the local region.
- ❖ Do not overload the maximum capacity to avoid damage to the device.
- ❖ The device is intended only for indoor use. Do not place the device where the temperature is below/above the operating range.
- ❖ Do not place the device close to objects with naked flames, heat source (oven or sunlight), cold source, liquid and extreme temperature changes.
- ❖ Keep the device away from water to prevent electric shock.
- ❖ Use the device opening clean and free of dust before installation. Dusty or dirty environments may prevent the proper operation of this device.
- ❖ Do not drop the device or subject it to physical shocks and strong vibration.

Declaration of Conformity

CT10x is in conformity with the essential requirements and other relevant provisions of the CE, FCC, and RoHS.

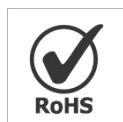

Copyright © 2011-2024 Milesight. All rights reserved.

All information in this guide is protected by copyright law. Whereby, no organization or individual shall copy or reproduce the whole or part of this user guide by any means without written authorization from Xiamen Milesight IoT Co., Ltd.

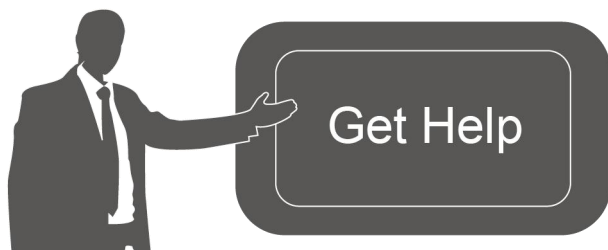

For assistance, please contact

Milesight technical support:

Email: iot.support@milesight.com

Tel: 86-592-5085280

Fax: 86-592-5023065

Address: Building C09, Software Park III,
Xiamen 361024, China

Revision History

Date	Doc Version	Description
Jan 12, 2024	V1.0	Initial version
Jun 6, 2024	V1.1	<ol style="list-style-type: none">1. Support flexible detachable design;2. Support cable temperature sensor.

Contents

1. Product Introduction	5
1.1 Overview	5
1.2 Features	5
2. Hardware Introduction	5
2.1 Packing List	5
2.2 Hardware Overview	6
2.3 Button and LED Indicator	6
2.4 Dimensions (mm)	6
3. Operation Guide	7
3.1 USB Configuration	7
3.2 LoRaWAN Settings	9
3.3 General & Alarm Settings	12
3.4 Maintenance	13
3.4.1 Upgrade	13
3.4.2 Backup	13
3.4.3 Reset and Reboot	14
4. Installation	14
4.1 Device Assembly (Alternative)	14
4.2 Antenna Installation	15
4.3 Transformer Installation	16
4.4 Transceiver Installation	16
4.5 Cable Temperature Sensor Installation (Alternative)	17
5. Communication Protocol	17
5.1 Basic Information	18
5.2 Sensor Data	18
5.3 Downlink Commands	19

1. Product Introduction

1.1 Overview

CT10x is a LoRaWAN® Smart Current Transformer for monitoring the energy and analyzing consumption remotely. CT10x provides multiple current options to suit energy monitoring and support sending threshold alarms. CT10x is detachable, the compact size and clamp design allow it to be installed in any indoor space quickly and safely without de-energizing a facility, simplifying the installation and saving the cost. Compliant with Milesight LoRaWAN® gateway and Milesight IoT Cloud solution, CT10x can be monitored via webpage or mobile App remotely. CT10x is widely used for energy motoring of smart buildings, machine failure detection and prevention, etc.

1.2 Features

- Report the RMS current and accumulated current data by minutes
- High measuring accuracy with a sampling frequency of up to 3.3 kHz
- Self-powered, free from batteries or external wires
- Utilize a sampling rate of up to 1s for real-time monitoring and quick alarm response
- Compact size allows for installation in narrow scenarios
- Support flexible detachable design to accommodate various installation environments
- Support to connect to a temperature sensor via USB for cable temperature measurement
- Non-invasive clamp design ensures easy and safe installation without the need for power de-energizing
- Equipped with LED indicator to indicate working status and alarms
- Compliant with standard LoRaWAN® gateways and network servers
- Compatibility with Milesight IoT Cloud

2. Hardware Introduction

2.1 Packing List



1 × CT10x Current
Transformer



1 × Transceiver
Cover



1 × Extension Cable
(1m)

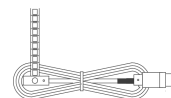

1 × Cable
Temperature Sensor
(1m)

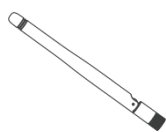

1 x LoRaWAN®
Stubby Antenna



1 x LoRaWAN®
Magnetic Antenna
(Optional)



1 x
Warranty Card



1 x
Quick Guide

! If any of the above items is missing or damaged, please contact your sales representative.

2.2 Hardware Overview

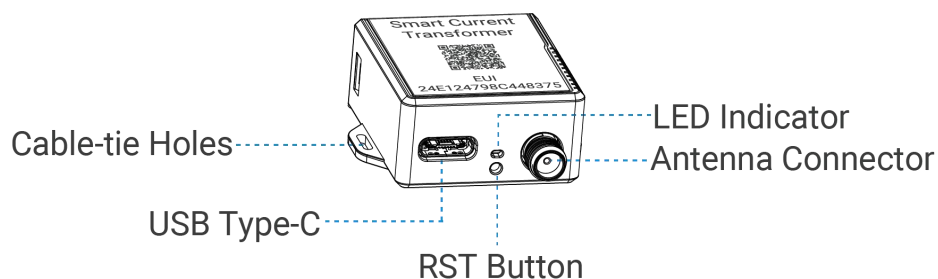

2.3 Button and LED Indicator

Function	Action	LED Indicator
Normal Work	The device is functioning properly.	Blinking every 2s
Low Power Mode	The device measures and reports at reduced rate.	Blinking every 5s
Low Voltage Mode	The device only measures at reduced rate.	Blinking every 10s
Alarm	The current is over the threshold or measuring range, or the temperature is over the threshold.	Fast Blinking
Reboot	Quick press the RST button once.	Blinking Once

Note: if not blinking even the device is installed, it is possible that the start circuit of the cable is too small and will take some minutes to charge the device.

2.4 Dimensions (mm)

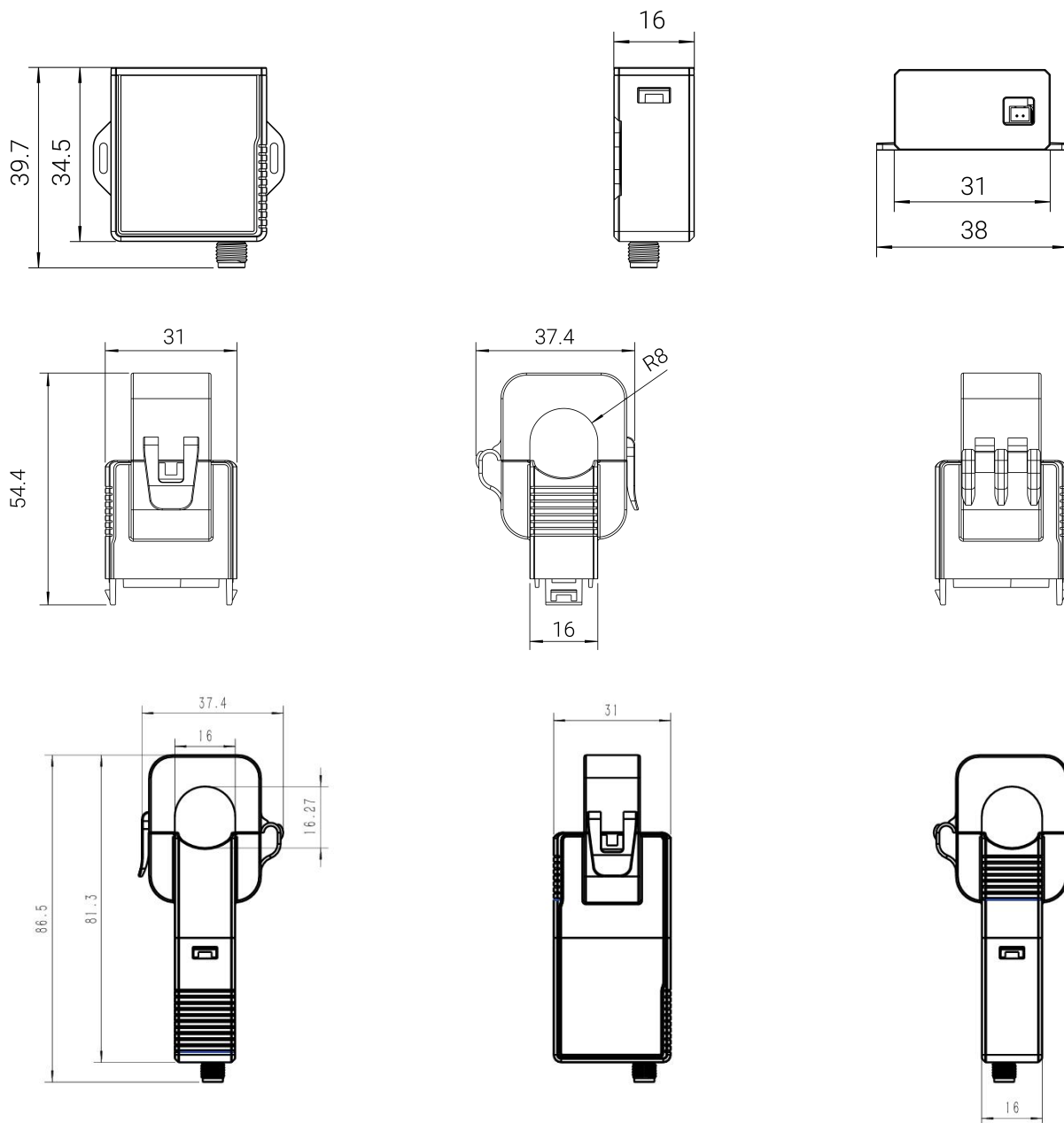

3. Operation Guide

3.1 USB Configuration

CT10x can be powered and configured via a Type-C port for configuration and debug.

1. Download ToolBox software from Milesight website.
2. Connect the device to a computer via the Type-C port.

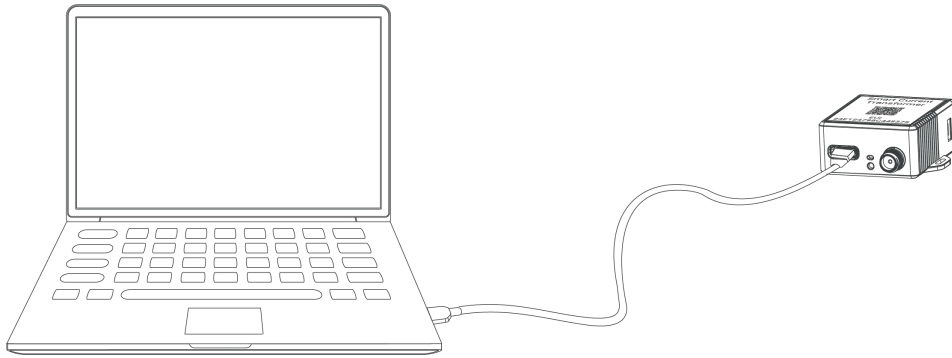

3. Open the ToolBox and select type as **General**, then click password to log into the ToolBox. (Default password: **123456**)

ToolBox Settings

Type: General

Serial port: COM4

Login password:

Baud rate: 115200

Data bits: 8

Parity bits: None

Stop bits: 1

Save Cancel

4. After logging into the ToolBox, you can check device status and change device settings.

Status >

Model:	CT103-915M
Serial Number:	6746D48016300014
Device EUI:	24e124746d480163
Firmware Version:	01.01-a3
Hardware Version:	1.1
Device Status:	On
Join Status:	De-Activate
RSSI/SNR:	-58/2
Current:	0.00 A
Max. Current :	0.00 A
Min. Current :	0.00 A
Accumulated Ampere Hour(Ah):	0.00 Ah Clear
Channel Mask:	████████████████
Uplink Frame-counter:	0
Downlink Frame-counter:	0

3.2 LoRaWAN Settings

LoRaWAN settings are used to configure the data transmission parameters in the LoRaWAN® network.

Basic LoRaWAN Settings:

CT10x supports basic configurations like join type, App EUI, App Key, and other information. You can also keep all settings by default.

Device EUI	<input type="text" value="24E124756C221863"/>
App EUI	<input type="text" value="24E124C0002A0001"/>
Application Port	<input type="text" value="85"/>
Join Type	<input type="text" value="OTAA"/>
Application Key	<input type="text" value="*****"/>
RX2 Date Rate	<input type="text" value="DR8 (SF12, 500k)"/>
RX2 Frequency	<input type="text" value="923300000"/>
Spread Factor	<input type="text" value="SF8-DR2"/>
Confirmed Mode	<input type="checkbox"/>
Rejoin Mode	<input checked="" type="checkbox"/>
Set the number of packets sent	<input type="text" value="32"/> packets
ADR Mode	<input checked="" type="checkbox"/>
TXPower	<input type="text" value="TXPower0-22 dBm"/>

Parameters	Description
Device EUI	Unique ID of the device which can also be found on the label.
App EUI	Default App EUI is 24E124C0002A0001.
Application Port	The port used for sending and receiving data, default port is 85.
Join Type	OTAA and ABP modes are available.
Application Key	Appkey for OTAA mode, default is 5572404C696E6B4C6F52613230313823.
Device Address	DevAddr for ABP mode, default is the 5 th to 12 th digits of SN.
Network Session Key	Nwkskey for ABP mode, default is 5572404C696E6B4C6F52613230313823.
Application Session Key	Appskey for ABP mode, default is 5572404C696E6B4C6F52613230313823.
RX2 Data Rate	RX2 data rate to receive downlinks.

RX2 Frequency/MHz	RX2 frequency to receive downlinks.
Spread Factor	If ADR is disabled, the device will send data via this spread factor.
Confirmed Mode	If the device does not receive the ACK packet from network server, it will resend data once.
Rejoin Mode	<p>Reporting interval \leq 35 mins: the device will send a specific number of LinkCheckReq MAC packets to the network server every reporting interval or every double reporting interval to validate connectivity; If there is no response, the device will re-join the network.</p> <p>Reporting interval $>$ 35 mins: the device will send a specific number of LinkCheckReq MAC packets to the network server every reporting interval to validate connectivity; If there is no response, the device will re-join the network.</p> <p>Note: Only OTAA mode supports rejoin mode.</p>
Set the number of packets sent	<p>When rejoin mode is enabled, set the number of LinkCheckReq packets sent.</p> <p>Note: the actual sending number is Set the number of packets sent + 1.</p>
ADR Mode	Allow the network server to adjust the data rate of the device.
Tx Power	Transmit power of the device.

Note:

- 1) Please contact your sales representative for the device EUI list if there are many units.
- 2) Please contact your sales representative if you need random App keys before purchase.
- 3) Select OTAA mode if you use Milesight IoT Cloud or Milesight Development Platform to manage devices.

LoRaWAN Frequency Settings:

Select supported frequency and channels to send uplinks. Make sure the channels match the LoRaWAN® gateway.

Supported Frequency :

<input type="checkbox"/>	Index	Frequency/MHz	Min Datarate	Max Datarate
<input checked="" type="checkbox"/>	0	<input type="text" value="868.1"/>	<input type="text" value="5-SF7BW125"/>	<input type="text" value="0-SF12BW125"/>
<input checked="" type="checkbox"/>	1	<input type="text" value="868.3"/>	<input type="text" value="5-SF7BW125"/>	<input type="text" value="0-SF12BW125"/>
<input checked="" type="checkbox"/>	2	<input type="text" value="868.5"/>	<input type="text" value="5-SF7BW125"/>	<input type="text" value="0-SF12BW125"/>
<input type="checkbox"/>	3	<input type="text" value="0"/>	<input type="text" value="5-SF7BW125"/>	<input type="text" value="0-SF12BW125"/>
<input type="checkbox"/>	4	<input type="text" value="0"/>	<input type="text" value="5-SF7BW125"/>	<input type="text" value="0-SF12BW125"/>
<input type="checkbox"/>	5	<input type="text" value="0"/>	<input type="text" value="5-SF7BW125"/>	<input type="text" value="0-SF12BW125"/>
<input type="checkbox"/>	6	<input type="text" value="0"/>	<input type="text" value="0-SF12BW125"/>	<input type="text" value="5-SF7BW125"/>
<input type="checkbox"/>	7	<input type="text" value="0"/>	<input type="text" value="0-SF12BW125"/>	<input type="text" value="5-SF7BW125"/>

If the device frequency is one of CN470/AU915/US915, you can enter the index of the channel that you want to enable in the input box, making them separated by commas.

Examples:

1, 40: Enabling Channel 1 and Channel 40

1-40: Enabling Channel 1 to Channel 40

1-40, 60: Enabling Channel 1 to Channel 40 and Channel 60

All: Enabling all channels

Null: Indicates that all channels are disabled

Supported Frequency :

Enabled Channel Index:

Channel Index	Frequency/MHz	Channel Spacing/MHz	BW/kHz
0 - 15	902.3 - 905.3	0.2	125
16 - 31	905.5 - 908.5	0.2	125
32 - 47	908.7 - 911.7	0.2	125
48 - 63	911.9 - 914.9	0.2	125
64 - 71	903.0 - 914.2	1.6	500

Note:
 64 channels numbered 0 to 63 utilizing LoRa 125 kHz BW starting at 902.3 MHz and incrementing linearly by 0.2 MHz to 914.9
 8 channels numbered 64 to 71 utilizing LoRa 500 kHz BW starting at 903.0 MHz and incrementing linearly by 1.6 MHz to 914.2

3.3 General & Alarm Settings

Basic Settings

Device Type

Reporting Interval (min)

Change Password

Parameters	Description
Reporting Interval	The interval of reporting current data. Default: 10 mins, Range: 1 - 1440 mins Note: when the device is under low power mode, the interval is fixed as 30 minutes; when the device is under low voltage mode, the device will stop reporting. The working mode can be judged by LED indicator.
Change Password	Change the password of the device for ToolBox configuration.

Alarm Settings

Current Threshold Value

Excessive Current Threshold A

Insufficient Current Threshold A

Temperature

Over °C

Below °C

Alarm Reporting Interval(min)

Alarm Reporting Times

Parameters	Description
Alarm Reporting Interval (min)	The interval to report alarm packet after alarm triggers. This interval should be less than reporting interval.
Alarm Reporting Times	Alarm packet report times after alarm triggers.
Current Threshold Value	
Excessive Current Threshold	The maximum current threshold value.
Insufficient Current Threshold	The minimum current threshold value.
Temperature	
Over	The maximum temperature threshold value.

Below

The maximum temperature threshold value.

Note: Current overrange alarm is fixed as enabled, the alarm reporting interval is fixed as 5 minutes and the alarm reporting time is fixed as 3.

3.4 Maintenance

3.4.1 Upgrade

1. Download firmware from Milesight website to your PC.
2. Go to **Maintenance > Upgrade**, click **Browse** to import firmware and click **Upgrade** to upgrade the device.

Maintenance >

The screenshot shows the 'Upgrade' tab selected in the maintenance interface. The interface includes a navigation bar with 'Upgrade' and 'Backup and Reset' tabs. Below the navigation bar, the following information is displayed:

Model:	CT103-915M
Firmware Version:	01.01-a3
Hardware Version:	1.1
Domain:	Beijing Server
FOTA:	<input type="button" value="Up to date"/>
Local Upgrade:	<input type="text"/> <input type="button" value="Browse"/> <input type="button" value="Upgrade"/>

3.4.2 Backup

CT10x supports configuration backup for easy and quick device configuration in bulk. Backup is allowed only for devices with the same model and LoRaWAN® frequency band.

1. Go to **Maintenance > Backup and Reset**, and click **Export** to backup the device configuration.
2. Click **Browse** to import the backup file, then click **Import** to load the configuration.

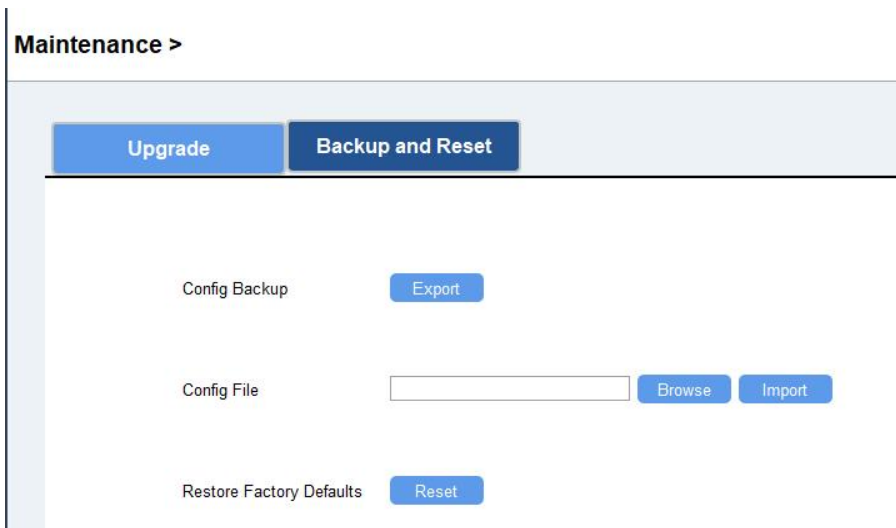

3.4.3 Reset and Reboot

Reset to Factory Default: Go to **Maintenance > Backup and Reset** of ToolBox, and click **Reset** to complete.

Maintenance >



Reboot: Quick press the RST button once or send downlink command to reboot.

4. Installation

4.1 Device Assembly (Alternative)

The CT part supports to be attached or detached from the transceiver.

1. Press the clip on the side with a screwdriver and separate CT and transceiver.

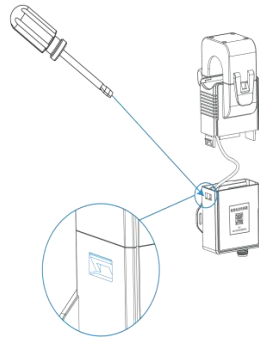

2. Disconnect the wiring socket of the probe from the transceiver, then connect the extension cable to the CT clip.

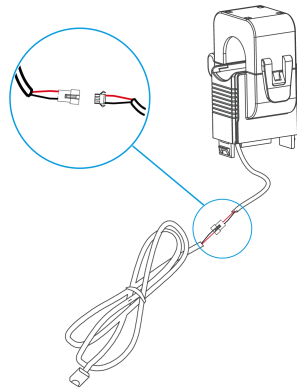

3. Pass the other end of the extension cable through the transceiver cover, then connect to the transceiver.

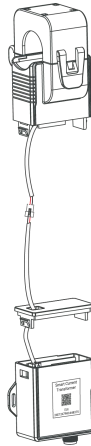

4.2 Antenna Installation

Rotate the antenna into the antenna connector. The antenna should be installed vertically and kept away from metal objects and obstacles.

Note: Keep the device away from metal objects, obstacles, or the environment surrounded by other electrical equipment that may cause interference. If necessary, please select a magnetic

antenna.

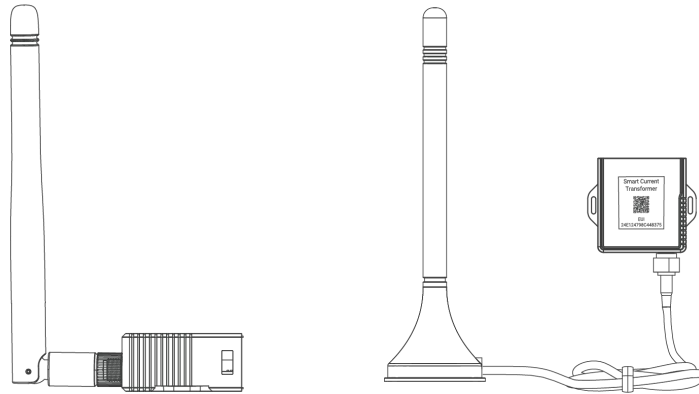

4.3 Transformer Installation

Open the current transformer to clip it around a single-phase wire. Then close the clip with a slight “click” sound to make sure the clip firmly grips the wire.

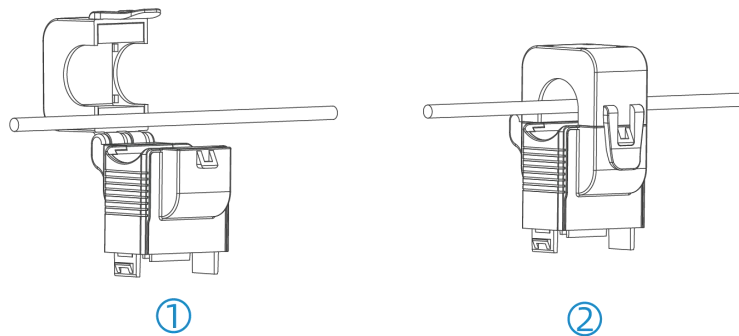

Note: Do not place Phase wire and Neutral wire within a single current transformer.

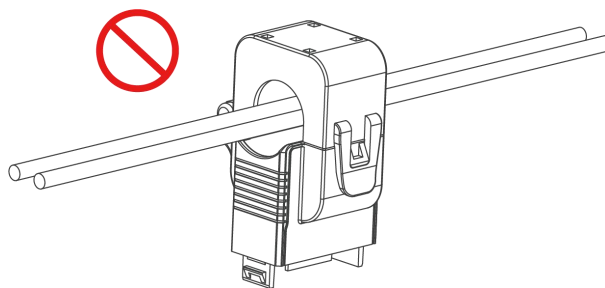

4.4 Transceiver Installation

The transceiver can be put or hang in any suitable position or to be fixed via cable-ties.

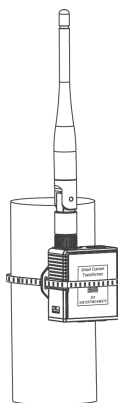

4.5 Cable Temperature Sensor Installation (Alternative)

CT10x can monitor the temperature of the wire through the Cable Temperature Sensor, it will alarm when the temperature exceeds the threshold.

Pass the Cable Temperature Sensor around the tested wire, and then tighten the buckle. The other end is connected to the CT10x device via the USB Type-C .

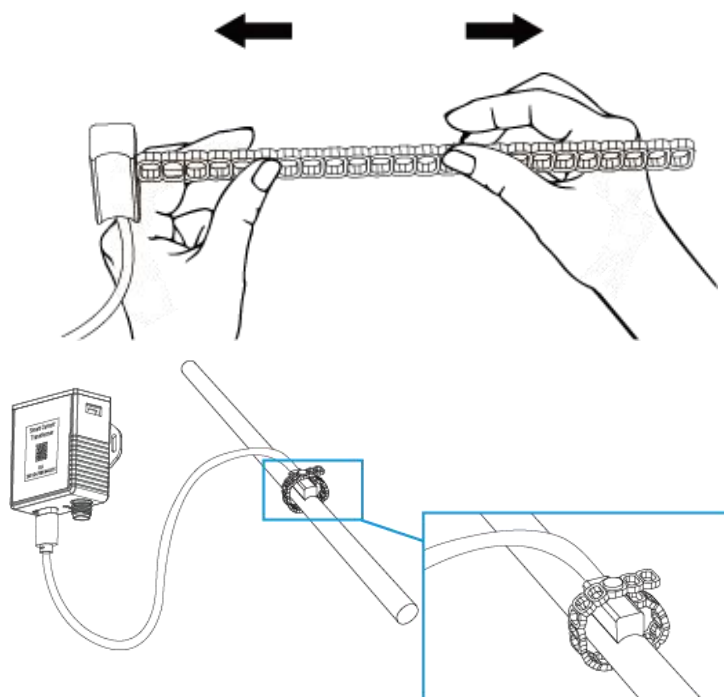

Note: Keep the Cable Temperature Sensor as close to the wire connector as possible to better detect the temperature.

5. Communication Protocol

All data are based on the following format (HEX), the Data field should follow little endian:

Channel1	Type1	Data1	Channel2	Type2	Data2	Channel 3	...
1 Byte	1 Byte	N Bytes	1 Byte	1 Byte	M Bytes	1 Byte	...

For decoder examples you can find at <https://github.com/Milesight-IoT/SensorDecoders>.

5.1 Basic Information

CT10x reports basic information of the device whenever it joins the network.

Channel	Type	Byte	Description
ff	01(Protocol Version)	1	01=>V1
	09 (Hardware Version)	2	02 10=>V2.1
	0a(Software Version)	2	01 01=>V1.1
	ff(TSL Version)	2	01 01=>V1.1
	0b (Power On)	1	Device is on
	0f(Device Type)	1	00 = Class A, 01 = Class B, 02 = Class C
	16 (Device SN)	8	16 digits

Example:

ff0bff ff0101 ffff0101 ff166746d48016300014 ff090110 ff0a0101 ff0f00					
Channel	Type	Value	Channel	Type	Value
ff	0b (Power On)	ff (Reserved)	ff	01 (Protocol Version)	01 (V1)
ff	ff (TSL Version)	0101 (V1.1)	ff	16 (Device SN)	6746d480 16300014
ff	09 (Hardware Version)	0110 (V1.1)	ff	0a (Software Version)	0101 (V1.1)
ff	0f (Device Type)	00 (Class A)			

5.2 Sensor Data

Item	Channel	Type	Byte	Description
Total Current	03	97	4	UINT32/100, Unit: Ah, Resolution: 0.01 Ah Note: when it reaches to max value FFFFFFFF (42949672.95), it will clear to 0 automatically.
Current	04	98	2	UINT16/100, Unit: A, Resolution: 0.01 A Note: FFFF means collection failure.
Current Alarm	84	98	7	Max. Current (2B) + Min. Current (2B) + Latest Current (2B) + Alarm Status (1B)

				Alarm Status: 01: Threshold alarm 02: Threshold alarm dismiss 04: Overrange alarm 08: Overrange alarm dismiss Note: Max./Min. Current means the maximum or minimum value between last report and current report.
Temperature	09	67	2	INT16/10, Unit: °C Note: FFFD means overrange temperature; FFFF means collection failure.
Temperature Alarm	89	67	3	Temperature (2B) + Alarm Status (1B) Temperature: INT16/10, Unit: °C Alarm: 01-Threshold alarm; 00-Threshold alarm dismiss

Example:

1. Periodic package: report as reporting interval (10 minutes by default).

039773020000 04980019 09673401					
Channel	Type	Value	Channel	Type	Value
03	97 (Total Current)	73 02 00 00=>00 00 02 73=627/100 =6.27 Ah	04	98 (Current)	00 19=>19 00=6400/100 =64A
09	67(Temperature)	34 01=>01 34=308/10=30.8°C			

2. Current alarm or alarm dismiss packet:

8498 b80b d007 c409 01		
Channel	Type	Value
84	98(Current)	Max. Current: b8 0b=>0b b8=3000/100=30A Min. Current: d0 07=>07 d0=2000/100=20A Latest Current: c4 09=>09 c4=2500/100=25A Alarm Status: 01=>Threshold alarm

5.3 Downlink Commands

CT10x supports downlink commands to configure the device. The application port is 85 by

default.

Command	Channel	Type	Description
Reboot	ff	10	ff
Reporting Interval	ff	8e	00 + Interval Time(2B), unit: min
Threshold Alarm	ff	06	9 Bytes, CTRL (1B) + Min (2B) + Max (2B) + Alarm Reporting Interval (2B) + Alarm Reporting Times (2B) CTRL: <ul style="list-style-type: none"> ● Bit2~Bit0: 000 - disable; 001 - below; 010 - over; 011 - within; 100 - below or over ● Bit5~Bit3: 001 - Current; 100 - Temperature ● Bit7~Bit6: 00 Max./Min. Threshold unit: A or 0.1°C Alarm Reporting Interval unit: min Alarm Reporting Times range: 1~1000
Clear Accumulated Current	ff	27	01 Note: when it reaches to max value FFFFFFFF (42949672.95Ah), it will clear to 0 automatically.
Alarm Reporting Interval	ff	02	2 Bytes, unit: min, range: 1~1440
Alarm Reporting Times	ff	f2	2 Bytes, range: 1~1000

Example:

1. Set reporting interval as 20 minutes.

ff8e 00 1400		
Channel	Type	Value
ff	8e (Reporting Interval)	14 00=>00 14= 20 mins

2. Reboot the device.

ff10 ff		
Channel	Type	Value
ff	10 (Reboot)	ff

3. Enable current threshold alarm and set maximum threshold as 60A, reporting interval as 2 minutes and reporting times as 5.

ff06 0a 0000 3c00 0200 0500		
Channel	Type	Value
ff	06	CTRL:0a=00 001 010=Current over maximum threshold Min: 00 00=0 Max: 3c 00=> 00 3c=60 A Alarm Reporting Interval: 02 00=>00 02=2 mins Alarm Reporting Times: 05 00=>00 05 =5

-END-